

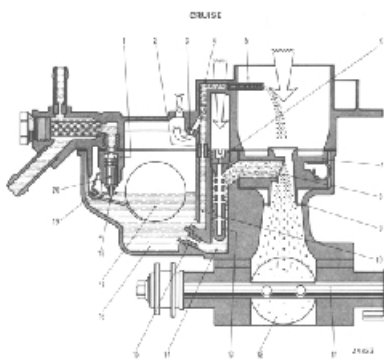

Intake, Combustion, and Exhaust Modifications
First Edition - November 2001
Brad Artigue

Contents

Introduction	3
What's on Your Car?	4
Understanding Performance	7
Establishing a Baseline	8
Modifications that Make Sense	9
Tuning Your Carburetor	17
Appendix: Dual Weber Carburetors	18



DIFFERENTIAL OPENING DEVICE OF THROTTLE VALVES

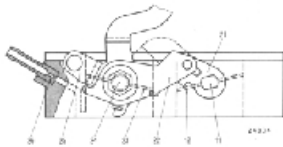

RECIRCULATING DEVICE OF BLOW-BY GASES

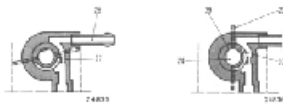

Credits etc.

Special thanks go to Thad Kirk and Pete Angel for contributing to and proofreading this document. Both are FIAT experts - Thad Kirk is thadkirk@hotmail.com, Pete Angel is pete@mirafiori.com.

Thanks to Troy McKaskle (troyckaskle23@hotmail.com) for proofreading and allowing me to work on his 32ADFA and 40IDF carburetors time and time again.

To Mike Richmond (mrichmond@aol.com), who started working with Weber IDFs about the same time I did and is an author of the appendix.

To everyone on Mirafiori (www.mirafiori.com) who ever mentioned the word "help" and "carburetor" in the same sentence. Your thoughts motivated me to work on these carbs.

Diagrams in this document were scanned with permission from the FIAT Spider Service Manual. This document is not intended for profit but for education, distribute it to anyone who needs the information.

Should you have questions or comments or note typographical errors please send me an email - brad_artigue@hotmail.com.

Introduction



Author's 1980 Spider 2000

If you own a FIAT Spider then you own a wonderful car. Superb handling, beautiful styling, easy to work on, and inexpensive to own, Spiders are a hobbyists' dream. I have owned several Spiders in the previous decade, all but one were carbureted. During the time that I was restoring each of these cars I did a lot of work with various carburetors and manifolds, trying to get as much performance as possible from "off the shelf" FIAT parts.

The results of this work are published in this document. It is an unofficial document, FIAT no longer really supports the Spider (it has been out of production for almost 20 years), and is really a compilation of years of work enjoying these fine cars.

This document is intended to explain the various carburetion systems used by FIAT on many FIAT and Lancia vehicles sold between 1966 and 1981. The most popular (and abundant) of these vehicles was the Fiat 124 Spider, but many other cars shared the same engine and carburetion systems. My personal experience is with the 124 Spider but the information in this document most likely includes your vehicle if it says "FIAT" or "LANCIA" on the outside and there is a belt-driven twin cam engine with a carburetor on the inside.

FIAT used Weber as the primary source of carburetors throughout the 60's and 70's. Underneath the hood of your FIAT is most likely a dual-barrel progressive downdraft carburetor (these terms are explained later). If your car is truly a European specification then you might have two dual-barrel synchronous downdraft carburetors. You may also have Solex carburetors or Dellorto depending on which manufacturer was on strike when your car was assembled.

If the above paragraph confused you, don't let it. In the next section you will identify just what you have on your car (because it may not be the original). In the third section we will discuss what you might need (vs. what you might think you need). The fourth section covers selecting the right manifold and carburetor, and the fifth and final section discusses tuning your Webers for optimum performance.

Be forewarned: if you intend to run a set of Solex, Dell'Orto, or some other setup then this document won't be much help. This document speaks specifically of Weber carburetors on FIAT engines!

For Additional Information

As you read through this document and begin to work on your car, you may want to check out the following online resources:

www.mirafiori.com - The FIAT Page - Includes an indispensable and lively owner's forum.

www.fiatspider.com - Also includes an owner's forum and gallery of member cars.

www.flu.org - FIAT/Lancia Unlimited - The FIAT and Lancia owner's club

What's On Your Car?

It is important to know what engine, cylinder head, carburetor, intake manifold, and exhaust system you have on your FIAT. Understanding what you have allows you to make an educated decision about what you need. If you are not 100% sure of what you have then take a few moments to check - many a Spiders with "2000" badges have 1800 engines and vice-versa.

Engine Identification

The engine identification number is stamped into the engine block near the oil filter. It is sometimes covered in grime, carburetor cleaner or degreaser and a brush will allow you to read it. On the Spider 2000 engine (1979-1985) it is located just to the right of the oil filter. On all Spiders manufactured prior to 1979 it is located above the oil filter.

Check your engine number with the chart on this page. Chances are you will have the correct engine in your car. It is important to note that the last few numbers may not match up - this usually indicates an engine swap at some point in your car's history. Never fear - if the first digits are correct then you have the correct size engine in your car.

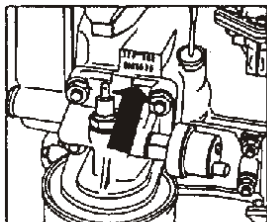

1975 - 1978 131 SEDAN, WAGON
1968 - 1978 124 SPIDER
1968 - 1975 124 COUPE
1970 - 1974 124 SEDAN, WAGON
1978 BRAVA - SUPER BRAVA

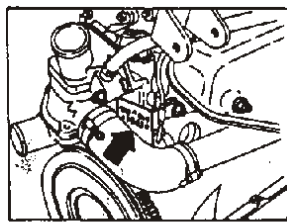

1979 - 1980 STRADA
1971 - 1979 128 SEDAN
1972 - 1975 128 WAGON
1972 - 1975 128 COUPE
1976 - 1979 128 3P
1974 - 1980 X 1/9

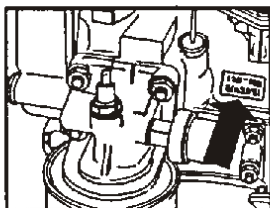

1979 - 1980 2000 SPIDER
1979 - 1980 BRAVA

Location of Engine Numbers

124 Model	Series	From S/N	Engine	Displacement
Spider 1968	124AS	0005619	124AC.040	1438cc
Spider 1969	124AS	0010554	124AC.040	1438cc
Spider 1970	124BS	0021861	124AC.040	1438cc
Spider 1971	124BS	0022589	124AC.040	1438cc
Spider 1971	124BS1	0033950	125BC.040	1608cc
Spider 1972	124BS1	0047032	125BC.040	1608cc
Spider 1973	124CS	0059592	125BC.040	1608cc
Spider 1973	124CS	0063308	132AC.040.3	1592cc
Spider 1974	124CS1	0071650	132A1.040.4	1756cc
Spider 1975	124CS1	0088792	132A1.040.5	1756cc
Spider 1975	124CS1		132A1.031.5	1756cc
Spider 1976	124CS1	0099909	132A1.040.5	1756cc
Spider 1976	124CS1		132A1.031.5	1756cc
Spider 1977	124CS1	0113343	132A1.040.5	1756cc
Spider 1977	124CS1		132A1.031.5	1756cc
Spider 1978	124CS1	0126001	132A1.040.5	1756cc
Spider 1978	124CS1		132A1.031.5	1756cc
Spider 1979	124CS2	0142649	132C2.040	1995cc
Spider 1979	124CS2		132C2.031	1995cc
Spider 1980	124CS2	0157654	132C3.040	1995cc

What's On Your Car?

Cylinder Head Identification

Cast into the top of your cylinder head is an embossed identification number. Because it is possible (and oftentimes desirable) to install an earlier cylinder head on some blocks, you need to identify if such a swap has occurred on your engine.

Casting Number	Other Casting ID	Original Engine Displacement	Comments
4166393	124AC	1438	1968 124 Spider
4198994	124AC	1438	1969 124 Spider
4232871	124AC.000	1608	Sport Spider
4232974	124AC.000	1608	1972 124 Coupe
4238527	132AB.1A.0	1592	Sport Spider
4239436	124AC.000	1608	124 Coupe
4239436	124AC.000	1608	124 Coupe
4268803	124AC.000	1608	1972-73 Sport Spider
4277590	132AB.9A	1756	1974-76 Coupe, Spider
4304781	132AC.OC	1592	1973-1974 Spider
4314402		1756	Late 124 Spider
4325215		1995	131
4326319	124AC	1608	Early 124
4348553	134AC.6C	1756	Lancia Scorpion
4371507	132.C8.1A0	1592, 1756, 1995	131/132 and 1981-82 Spider
4372281		1995	1980 Lancia Beta
4372291	134AS	1756, 1995	1977 Spider
4372297		1592, 1995	131
4372748		1995	131
4406111	132AC.2C	1995	1979 131 & Beta Coupe
4439644	132AC.2C	1995	79 Carb Brava
5992129		1995	1984 Spider

What if your casting number is not on this chart? Do not be alarmed, this chart is a work in progress and its contents are maintained by Pete Angel. Send him your engine displacement and casting number via email: pete@mirafiori.com. Include as much of the casting number as possible along with the year and model of the vehicle.

Carburetor Identification

Weber stamped an identification number on your carburetor body. Depending on the construction of the carburetor body, this number may be stamped between the middle and lower halves of the carburetor, or on the lowest mounting flange on the intake side. It may be in a different location altogether but should be fairly easy to spot. The number may be quite long, but the primary information is in the first few alphanumeric characters.

For example: 28/32 ADHA 1/100 or 32ADFA5 1/105

The important thing to note is the numbers before the letters and the letters themselves. If you read "28/32 ADHA 1/100" then you can simply note that you have a "28/32 ADHA".

Using the chart on the next page, note whether or not your carburetor was original equipment on your engine. Carburetor swaps are extremely easy on FIATs and are the focus of much of this document!

What's On Your Car?

Carburetor Identification (continued)

This information is valid for FIAT Coupes and Spiders imported into the U.S. and sold through U.S. dealerships. Owner-imported cars may have dual carburetors or different models as original equipment.

<u>Vehicle</u>	<u>Year</u>	<u>Displacement</u>	<u>Carburetor</u>
Coupe and Spider	67	1438	34 DFH
Coupe and Spider	68-69	1438	26/34 DHSA
Coupe and Spider	70-71	1438	26/34 DHSA
Coupe and Spider	71-73	1608	28/34 DHSA
Coupe and Spider	73	1592	28/34 DHSA
Coupe and Spider	74	1756	34 DMSA
Coupe and Spider	75-76	1756	32 ADFA
Spider	77-78	1756	32 ADFA
Spider 2000	79-80	1995	28/32 ADHA

Exhaust System Identification

Identifying your exhaust system is actually quite easy - there are no numbers or charts to compare and all you really have to do is look in your engine compartment. FIAT used two basic system designs on carbureted engines. The first design is traditionally called the "4-1" or "four into one" system. The second is known as the "4-2-1" type.

Look in your engine compartment at the exhaust side of the engine. There may be a metal heat shield on top of the exhaust, it will have three 13mm nuts securing it down. If you cannot see under the shield you may need to remove it (with the engine cold!) to see what you have.

The 4-1 type will have four short pipes, one from each cylinder, terminating into a single large pipe that routes under the car.

The 4-2-1 type has a 4 into 2 cast manifold. A steel downpipe connects to the manifold and merges (collects) the two pipes into a single pipe that routes underneath the car.

Intake Manifold Identification

FIAT used two basic types of intake manifolds on carbureted engines. Although there are identifying numbers on the castings, no reference has been made available that accurately categorizes them. The easiest way to identify what you have is to remove the carburetor and look at where it bolts down. If there is a single hole and a large chamber then you have a "single plane" manifold. If there are two distinct sections, one for the primary barrel and one for the secondary, you have a "dual plane" manifold.

Identification without removing the carburetor is more challenging. The Spider 2000 - 1979 and 1980 - has the largest manifold and it is nearly flat on top. It has a "waffle" pattern cast into it and several ports for emission control equipment. It is very angular in appearance.

The Spider 1800 has a more simplistic manifold with four pipes (one per cylinder) and space between the pipes. It is much more curved in appearance. 1800's have a "christmas tree" of ports on the front. The Spider 1608 and 1592 manifolds are very similar to the 1800 but typically have only a port for the brake booster.

Spider 1438 manifolds are *not* interchangeable with other cylinder heads because they lack the coolant passage rearward of the #4 intake runner.

Understanding Performance

What is Performance?

per·for·mance (pr-fôrmns)

n.

The act of performing or the state of being performed.

The act or style of performing a work or role before an audience.

The way in which someone or something functions: *The pilot rated the airplane's performance in high winds.*

A presentation, especially a theatrical one, before an audience.

Something performed; an accomplishment.

Performance, therefore, is a relative term. You need to define how you want your engine to perform so that it suits your needs.

Look at it this way: I used to own a FIAT 850 Spider, with a 903cc engine that produced around 62 horsepower. It was a rebuilt block, all bored out and with a nice polished cylinder head. It had a carburetor upgrade and a nice exhaust system. In terms of performance it was a *high performance engine*. How? First, it surpassed my expectations in terms of how smoothly it operated. Second, it got better fuel economy than I ever expected. Third, it produced more horsepower than I projected. I was getting 62 HP from a 903cc engine with a tiny carburetor and antique cylinder head design! Relative to my expectations (I expected it to perform well) it was a high performance engine.

Now look at it another way: Lots of car companies state that their engines are "high performance" just because they produce more than "x" horsepower or "y" torque. But look at what these companies do to produce this power - enormous V6 and V8 engines that barely produce $\frac{3}{4}$ of a horsepower per inch of engine displacement. You have 350 and 400 cu. in engines producing under 300 HP. Alfa Romeo and FIAT were producing 1HP per cubic inch of displacement in the 1960's. Sure, the engines produced around 100 to 120HP, but which one is higher performance? My money is always on the engine that is most efficient.

Finally, judge for yourself. Do you want to build a 200HP Spider? It can be done, with a standard FIAT engine block, cylinder head modifications, high compression pistons, lightened flywheel and connected rods, supercharging, etc. Do you want a (slightly less expensive) 100 to 120HP Spider that gets good gas mileage, has few mechanical problems, and can last for 50 to 100,000 miles? Most of us desire the latter, a car that you start in the morning, drive all day (even in traffic), and enjoy.

Underneath the hood of your Spider is an engine that was designed to perform efficiently and reliably. If someone contradicts this, they are not aware of the potential of the FIAT DOHC design. Without getting into a history lesson, FIAT's belt-driven DOHC configuration has been duplicated by most other auto manufacturers. It is elegantly simple and wonderfully effective. And, unlike most engines made today, you can work on it.

Establishing a Baseline

You've already started

Using the information you've already gathered (engine type, head type, etc.) you are already on your way to establishing a baseline for your engine's performance. The recommendations in this section are optional, but you really should get a feel for how your existing setup operates before trying to change anything.

Things to check/replace prior to getting started with any modification:

1. Ignition system: as necessary, new plugs, wires, distributor cap, rotor, vacuum advance capsule and hose, coil, pickup, points, condenser, points gap, dwell setting. Set the ignition timing to exactly what your car's instruction book calls for.
2. Valve lash: make sure the valve lash is within specification.
3. Coolant: make sure the cooling system is properly filled.
4. Oil: FIAT recommends 15W40 oil and a new filter with every oil change.
5. Gas: Fill up with the highest octane you can get from the pump.

Why do I recommend you do all of these things? You are getting ready to make changes to how the engine breathes. Prior to doing that you have to know exactly how it operates in its current state. In other words, you cannot intelligently move from point "A" to point "B" when you don't know what "A" really is. And if any of the five things above have not been attended to in a while, you've lost track of what "A" really is anyway.

Once you've done the things above, drive the car and make observations. How fast is the car from 0 to 60 MPH? How responsive is the throttle? How good is your gas mileage? Does the car do bad things, like foul spark plugs, start poorly on cold days, etc?

At the point where you are completely comfortable with the current operating condition of your car, ask yourself: is it good enough? If you are happy with the speed of the car, happy with the way everything works, do you really want to start changing things? If not then don't be ashamed, enjoy your car. If you do want to make some changes then keep reading about the different options you have available to you.

Modifications that Make Sense

Exhaust System

I'm starting with the exhaust system because the necessary changes are universal for the DOHC engines. Many of you will be able to skip this section as you already have an adequate exhaust system. Without getting into exhaust system theories, there are some basic ideas that need to be understood. First, an exhaust system needs to be as unrestrictive as possible while still providing adequate back pressure for engine operation. In other words, a straight piece of 2" pipe from each cylinder is not "free flowing" - it will result in awful engine operation. People who design exhausts spend time in planning the way they work, the curves, length of the runners, size of the pipes, etc. Your only job is to use what they have to meet your needs. There are roughly two options when discussing the pipes from the engine to the catalytic convertor (or at least under the car if you have no catalytic convertor):

1. Install (or continue using) a FIAT 4-2-1 exhaust system, replacing the 4-1 exhaust that you already have. This results in better flow and much better high end performance. Frankly, it also sounds better.
2. Install a custom-made header. These are typically four long runners into a single collector and are made of thin steel. They are louder than an iron stock exhaust and many people swear by them. I have not personally found them to be any more efficient than the stock 4-2-1 system.

Underneath the car you may or may not have a catalytic convertor. If you do (and if it is old) consider replacing it with a free flowing unit. These units use a platinum honeycomb core rather than stones to do their job. They are more efficient and help you obtain more power.

Behind the catalytic convertor is a center resonator, located just in front of the axle. Three options are available: the stock type, a "performance" type, and a straight pipe. The stock type of resonator is adequate for nearly any kind of street use. It is typically manufactured by ANSA (or TESH, the same company) and is around \$75. These tend to rust so check yours and replace if necessary. The performance type is, unfortunately for those who buy them, basically the exact same thing with a black powder coating. Many vendors do not stock them for this reason. The third option, a straight pipe, results in a different exhaust note.

The exhaust "tip" (the part that sticks out under your rear bumper) is available in stock and performance versions as well. You can also get various types of straight pipes, trumpets, etc. The stock ANSA/TESH rear section is more than adequate for street use, is generally well made, and hangs properly under the car. My experience with the twin-tip "performance" exhausts is that they result in a louder (some say "throaty") exhaust note but do not improve performance. You may have to modify early Spiders to accommodate the twin-tip style muffler. If nothing else, consider them a cosmetic change. Other types of tips (certainly the "trumpet") are much louder and less restrictive, but keep in mind that ALL of these designs are generally unrestrictive and well suited for street use.

Modifications that Make Sense

Exhaust System (continued)

I believe that everyone should run a 4-2-1 front section or performance header, a honeycomb type catalytic convertor (if necessary), a stock center resonator, and stock rear section. These components provide admirable service for street use and do not impair the performance of a good street engine.

Intake Manifold

As discussed earlier, there are two basic types of intake manifolds. A single plane manifold is essentially a plenum chamber in which both carburetor barrels add to the mixture. A dual plane manifold separates the barrels into two plenums and then independently into each intake runner. The single-plane type is necessary for any carburetor with a mechanical secondary, the dual-plane is typically used when the carburetor has a vacuum-operated secondary. These concepts are explained in the next topic.

The ideal intake manifold is the one used on the 1756cc engines. It is a fairly compact single-plane manifold with few ports (so you need to do less work blocking these ports off). It will fit on every DOHC cylinder head and fit all of the Weber carburetors described in this document.

If your stock carburetor was installed on a dual-plane manifold and you intend to retain that carburetor, continue to use the stock dual-plane manifold. The most obvious example is the Spider 2000 (1979 and 1980 carbureted models) with the Weber ADHA and dual-plane manifold. These components were designed to function together. The ADHA on any other manifold performs poorly; any other carburetor on the 2000 manifold is restricted in its efficiency.

Carburetors

Carburetors are the most likely reason you are reading this document. Over the next few pages we will discuss the types of carburetors FIAT used and which one will be the best fit for your car. You've already done the work in identifying which carburetor you have on your car. The chart presented in this topic will educate you in the basic operation of the carburetor and if you should consider swapping it out for another unit.

Also discussed in this section are the true upgrade carburetors, selected by FIAT or FIAT vendors as suitable for use on our engines. Because they are available brand new they may be a great option for those of us not wanted to rebuild an old carburetor.

The chart on in this section splits carburetors into two primary categories and then into secondary categories. The primary category is *type of operation*, the secondary category is *type of cold start device*. These concepts are as follows:

Modifications that Make Sense

Carburetors (continued)

Type of Operation: Vacuum or Mechanical.

A vacuum operated carburetor uses intake manifold pressure to open the secondary barrel at a specific point in time. For example, the Weber ADHA carburetor is designed to begin opening the secondary barrel at around 3500 RPM under a running load. A mechanical carburetor uses two gears or a lever system to always open the secondary barrel when the primary barrel is at a certain angle.

The advantage of a mechanical secondary is obvious: regardless of engine speed and load you can deliver more air and fuel to the engine as you require it. The result is much better acceleration, better passing ability, and better throttle response. The carburetor acts exactly as your foot requires.

A vacuum operated secondary will not act in such a fashion. At rest you can often completely depress the gas pedal and redline the engine without the secondary ever opening -- all because the engine (at rest) doesn't generate enough pressure to pull open the secondary. It is a more fuel-efficient design and is a good bit smoother during transition to the secondary barrel.

Type of Cold Start Device: Manual, Automatic, Electrical

A cold start device is known as a "choke" to us Americans. It is typically a flap of metal over the primary carburetor barrel that restricts the flow of air (resulting in a rich mixture). It is necessary for cold mornings when fuel doesn't want to atomize.

A manual choke is operated by a cable-and-knob with the driver pulling the knob out to engage the choke or in to disengage. 1960's and most 1970's Spiders have mechanical chokes.

An automatic choke is operated by routing coolant into a special chamber on the carburetor. Inside the chamber is a spring that expands when hot. As it heats up the choke flap begins to close. Prior to starting the car the driver will fully depress the accelerator and release it, thus setting the choke. Operation is then automatic.

An electrical choke has a temperature sensor that operates in place of the coolant mentioned above. More elegant in operation, the driver does nothing but start the engine. The choke engages automatically and all operation is also automatic.

Modifications that Make Sense

Carburetors (continued)

Carburetors by Type of Operation, Type of Cold Start Device

	Vacuum Operated	Mechanically Operated
Manual Choke	DFH ADHA DHSA	DMSA
Automatic Choke		ADF ADL ADHA
Electrical Choke		DFEV

Vacuum-Operated Carburetors: The DFH, DHSA, and ADHA

The DHSA and DHSA2

The DHSA was installed on the original 124's up to 1971. Difficult to find parts for and generally notorious for secondary vacuum leaks, the DHSA is not a popular upgrade nor is it recommended as a candidate for a rebuild.

The DHSA2 and later models were used from 1971 through 1973 and offered larger primary and secondary barrels. Difficult to find parts for and often hard to rebuild correctly, unless absolute originality is required, this carb should be removed and replaced with a later, mechanically-operated model.

It is difficult to find parts for the DHSA series, although the vacuum operated secondary diaphragm can still be had new. Rebuild kits are also available but some of the items are simply impossible to find.

The ADHA and DFH

The ADHA was installed on 1979 and 1980 49-State Spiders (or those not imported into California). The DFH is rare, used on very early Spiders. Both operate using a large vacuum operated secondary located near the secondary barrel. The ADHA has a tiny 28mm primary barrel and a 32mm secondary barrel. It is designed for emissions control and not performance and is to blame for much of the 1979/80 Spider's sluggish operation.

ADHA and DFH carburetors are not easy to rebuild; the ADHA can still be purchased new.

Modifications that Make Sense

Carburetors (continued)

Mechanical Carburetors with Manual Chokes: DMS

The 34DMS / DMSA

The DMS/DMSA series was, and still is, extremely popular. Inexpensive, even when purchased new, a DMS carburetor will bolt right on to your Fiat, link up, and run. It has a mechanically operated secondary and choke, and even the DMSA has few emissions control provisions.

The DMS can be an impressive performance increase over stock DHSA and DFH carburetors, and retains fuel economy. You can retain the originality of the mechanical choke yet gain a good amount of performance (the DMS is a more powerful carb than a DHSA). It will also fit under one of the stock Fiat air cleaners if you intend to do so. Anyone can learn to install and tune a DMS carburetor.

If you intend to use the DMS on a later model car (where the throttle lever is cam-box mounted) then you will have to order a different throttle "pull" assembly for the carb. This is easy to replace and costs about \$10.

Mechanical Carburetors with Automatic Chokes: ADF, ADFA, ADL

The 32ADFA

The 32ADFA is probably the most prevalent Fiat Spider carburetor on the "used carbs" circuit. Large, well-built, and reliable, the 32ADFA bolts right up to the Single-Plane manifold (used on the 1756cc cars) and can therefore be installed (with the manifold) on any Fiat 124. It has a mechanically operated secondary and automatic choke, and like the DMSA has few emissions control provisions.

Impressive performance increase for DFH, DHSA, and ADHA owners - and retains fuel economy. Automatic choke retains originality for stock and later model cars. Also fits under stock Fiat air cleaners for those wishing to maintain originality. A great performance increase for all Spiders not originally equipped with the ADFA, including the 1979 and 1980 cars. Vehicles will still pass 49-state emission control laws.

If you intend to use the ADFA on a later model car (where the throttle lever is cam-box mounted) then you will have to use the throttle "pull" assembly from your ADHA. If you intend to use the ADFA on a pre-1975 model year car, you will have to install the heater pipe (runs under the exhaust manifold) from a 1975+ model year Fiat 124. This heater pipe has the necessary fitting for running the ADFA's water-heated choke. You will then have to run coolant hoses from this heater pipe and the intake manifold to the carburetor choke assembly.

Modifications that Make Sense

Carburetors (continued)

The 34ADF

One of the best carburetors made for the 124. Solid and extremely reliable, the 34ADF was provided (by Fiat, actually) as a bolt-on performance improvement for 1975+ Fiats. Nearly identical in manufacture to the 32ADFA, the 34ADF lacks the emissions control ports of the ADFA and has larger primary and secondary barrels, improving performance throughout the entire r.p.m. range. Requires the Single-Plane manifold to operate efficiently. Has an automatic choke.

A great performance increase over any stock Fiat carburetor. Available new. Parts interchange with ADF and ADL series carburetors - and these parts are easy to find and cheap. Can be used under Fiat air cleaners, although a "free flowing" type is suggested. Vehicles will still pass 49-state emission control laws.

The 34ADF is expensive - average price is \$400 to \$500, not including the Single-Plane manifold (if needed) which average about \$75. If you intend to use the ADFA on an pre-1979 model car (where the throttle lever is manifold mounted) then you will have to use the throttle "pull" assembly from your existing ADFA or DHSA carb. If you intend to use the ADFA on a pre-1975 model year car, you will have to install the heater pipe (runs under the exhaust manifold) from a 1975+ model year Fiat 124. This heater pipe has the necessary fitting for running the ADFA's water-heated choke. You will then have to run coolant hoses from this heater pipe and the intake manifold to the carburetor choke assembly.

The 36ADL and 38ADL

Similar to the ADF series in most respects, the ADL was designed for the Lancia Gamma 1995cc and 2800cc cars (neither of which were sold in the U.S.A.) Hard to find, the ADL series can add serious performance where a single-carb is required. ADL carburetors, like the ADF, have a water-activated automatic choke.

Available new (but rare!) and much easier to find in Europe than in the U.S.. The 36ADL is a remendous performance increase over stock. To be truly effective you need to increase the compression in your engine to at least 8.9:1 and possibly add higher lift/duration camshafts. I ran a 36ADL on a stock compression 2 liter engine with an 1800 head and stock cams with wonderful results.

Mechanical Carburetors with Electrical Chokes

The DFEV

Our deviant from the manual/water choke fold is the electric choke DFEV, available new from parts vendors and with two huge barrels. A more modern design than the ADL or ADF, the DFEV offers the same basic benefits (and the same difficulties when mounting to a pre-1979 engine).

Note that the DFEV requires a positive lead (energized by the ignition key) to operate the electric choke.

Modifications that Make Sense

Carburetors (continued)

Which carburetor should you run? I have no idea as I am not you. I can make some recommendations that should help you along. Given some rather ideal circumstances (as in, money is no object), consider the following solutions:

For Spiders currently fitted with DHSA, or DFH

For DHSA and DFH owners, purchase an 1756cc intake manifold. Remove from it (and block off) all ports except the brake booster pipe. For those who already have the 1756cc manifold, remove it and block off same. Install a 34DMS carburetor. It will work with your existing linkage and choke mechanism and provide an instant power and reliability increase.

For Spiders currently fitted with ADFA or ADHA Carburetors

For ADHA owners, purchase an 1756cc intake manifold. Remove from it (and block off) all ports except the brake booster pipe. For those who already have the 1756cc manifold, remove it and block off same. Purchase a Weber 34ADF and install it. Early ADFA Spiders may have a lever type throttle assembly, the 34ADF may have to be modified to operate it (consult with your vendor).

Money is no object? Consider that a 34DMS is around \$350 and a 34ADF is around \$450. That may be too much for some people to handle, so here are some other alternatives. Keep in mind that any used carb you find needs to be rebuilt by a knowledgeable person - probably YOU. You can find these parts off old junkyard Spiders or on the used circuit:

For Spiders currently fitted with DHSA and DFH Carburetors

Purchase an 1756cc intake manifold. Remove from it (and block off) all ports except the brake booster pipe. Install a 34DMS carburetor from an a 1974 Spider. These carburetors were available new just a few years ago but may be hard to find today; your best bet may be finding a used Spider or other vehicle fitted with the 34DMS. It will work with your existing linkage and choke mechanism and provide an instant power and reliability increase. Depending on engine displacement you may have to decrease the main jet and idle jet sizes.

For Spiders currently fitted with ADHA Carburetors

Purchase an 1756cc intake manifold. Remove from it (and block off) all ports except the brake booster pipe. Purchase a Weber 32ADFA and install it. The 32ADFA will bolt right up - install your choke hoses and vacuum advance and away you go! It will require increasing the size of the main and idle jets by 5 - in other words, if your idle jet is currently 55 you should go with a 60. But TRY the 55 first.

Modifications that Make Sense

Cylinder Heads

The cylinder head on your car is likely the correct one for the model year. In most cases (1438cc, 1608cc, 1756cc, 1592cc) I say to stick with your existing cylinder head. But the 1995cc (2000 Spider) engines can benefit from the slightly smaller combustion chambers of the 1756cc cylinder head. The smaller combustion chambers result in increased compression - desirable for performance. From "seat of the pants" observations made by myself and many others who have performed this modification, you can expect better acceleration and better performance at high speeds. Best yet, there is no magic to doing it - if you can replace the head gasket then you can replace the cylinder head. Your existing 1995cc cam boxes, wheels, valves, etc. will all fit perfectly.

If you are running a 20+ year old cylinder head with no idea of its history, consider buying or rebuilding your head. FIAT cylinder head parts are pretty darn cheap (\$70 for all eight valves). I generally send the heads to a machine shop for surfacing, bead blasting and (when necessary) installing new valve guides (the early brass valve guides are not as durable as the late steel type, check/replace yours). I then assemble the head myself with new springs, valves, retainers, keepers, cups (if necessary), and shims. It will result in a car that really runs well.

Porting and polishing are techniques that your machine shop can assist you with. Getting the ports and chambers opened up (ported) and shiny (polished) results in better airflow throughout the cylinder head. Better airflow=more power. It is easy to spend over \$1000 on a performance cylinder head - and the results may be only 1-2 horsepower over a well assembled and clean head. Why? Because a performance head with stock cams and carburetion is a waste of time. You'll need high lift/duration camshafts and a carburetor more powerful than any of the stock units (at least a 34DMS or 34ADF).

Cylinder heads are not necessarily compatible between engine displacements. To test yours, get a head gasket made for the cylinder head you want to install (ie a 1438 gasket for a 1438 head). Place the gasket on your block and make sure that ALL of the passages line up. Do not assume that blocking any passage is OK (though some are) - find someone who has done what you want to do first.

This document is really not designed to take you through the steps of rebuilding a cylinder head. If you wish to learn about the engineering behind cylinder heads, theories of combustion and airflow, etc. then purchase a copy of Guy Croft's book Modifying and Tuning FIAT and LANCIA Twin Cam Engines.



Bead Blasted Head with new Valves, Springs, Retainers, etc.

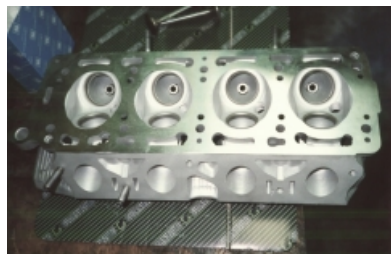

Head surfaced by machine shop - note the mirror-like finish.

Tuning Your Carburetor

Preliminary Settings

Note: These is the recommended procedure per Weber with some modifications, you will find the same general steps in any publication on setting up carburetors.

Check Factory Settings

Do not rely on the factory settings unless otherwise directed by your vendor.

Back out the idle speed screw (see figure) until it is no longer in contact with the throttle stop lever. Now turn the screw until it contacts the lever and again 1 ½ turns.

Turn the idle mixture screw (on our carburetors it is typically in the center bottom of the carburetor body) in until it is fully seated - do not force the screw. Now turn it back out two full turns.

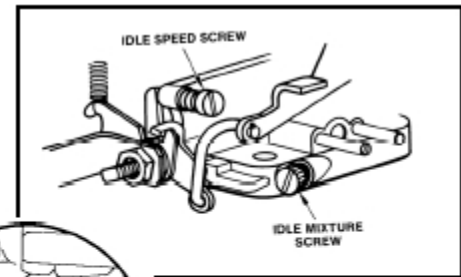

Start and warm the Engine

Disengage or block the choke open. On automatic chokes you can use a small clamp or wire to pull the choke mechanism open.



The engine should start and run poorly (if it does not then increase the idle speed screw ½ turn until it does). Adjust the idle speed screw until the engine runs at approximately 900 RPM.

Turn the mixture screw in (lean the mixture). If the engine increases in speed then continue to turn until it is no longer increasing or runs worse, then back the screw out ½ turn. If the engine decreases in speed then turn the screw out until it is increasing in speed. Continue to turn until it is no longer increasing or runs worse, then turn the screw in ½ turn. Adjust the idle to approximately 850 RPM.

Let the engine warm up to operational temperature. On a Spider you will wait until the fan has cycled two times (on-off-on-off).

Final Settings

Note: should the engine fan come on during these steps STOP working until it shuts off.

Set the idle speed screw so that the engine runs at 850 RPM, or 900 RPM if you have air conditioning. Recheck the mixture screw by turning slightly in then out. Engine speed should be set - using the mixture screw ONLY - to the fastest and smoothest point of operation (listen for exhaust popping). Reset the idle speed screw as necessary.

Appendix: Dual Weber Carburetors

The Mystique

Dual Webers are just plain neat to work on, look at, and operate. They are loud, powerful, and demonstrate your ability to really tackle carburetion. Many FIAT owners consider installing twin Webers on their FIAT engine, and many have taken the plunge. This appendix deals with this subject and includes excerpts from an article by Mike Richmond (msrichmond@aol.com) which is available in its entirety at www.mirafiori.com/faq/content/idf.html.

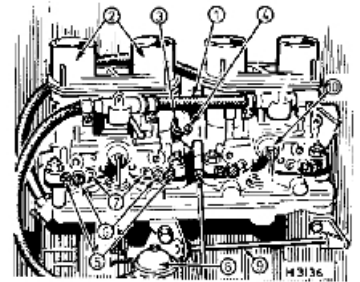

Dual Carburetor Configurations

There are configurations that you should consider if you want to work with twin carburetors. They are both Weber products, Solex and Dellorto configurations are *not* listed because they are not available new and parts can be nearly impossible to find.

These carburetors are downdraft, two-barrel, synchronous operating units. Each barrel is fully independent of the other and can be tuned as such. Barrels share only the fuel bowl and accelerator pump. They require special manifolds to work - manifolds without plenums, so each cylinder has a unique runner to its own carburetor barrel. The two models used on FIATs are the Weber IDF and DCNF.

The Weber IDF is available in 40, 44, and 48mm configurations. 40mm is the most popular and is sold as a kit by many vendors. The kit includes the manifold, gaskets, carburetors, linkages, and air cleaners. It generally sells for just over \$1000. Dual Weber 40IDFs were also used by FIAT as a *standard* system on the 1608cc 124 Sport Spider. If you can find an original setup it will have a FIAT intake manifold and the original linkage setup. These setups are selling in the \$700 range without the air cleaner. The original air cleaner ("turtleback") sells for around \$250 used.

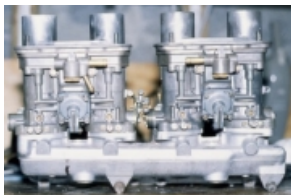

Front View, Weber 40IDF13/15
as original from FIAT 1608 Spider



Top View

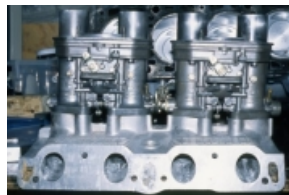

Manifold with Carburetors

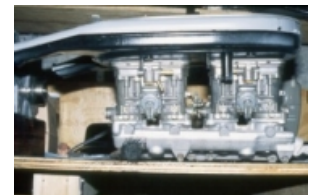

Complete Configuration with
"Turtleback" air cleaner

Appendix: Dual Weber Carburetors

Dual Carburetor Configurations (continued)

The second popular configuration is the Weber DCNF, available in 40 and 44mm sizes. The 40DCNF is a more compact and modern design, but the operational principles are the same as the IDF. Generally speaking, a set of DCNFs will cost more because the manifolds are a bit more expensive. However, the manifolds are also a bit higher in quality and design than the IDF manifolds. Ultimately, the choice is yours. FIAT used IDFs so many people choose those. I have used both and have been very pleased with them.

How much power will I get?

About 25% more than a stock single carb, which is very restrictive. You are literally doubling the venturi area when you go to dual carbs over stock. Compared to fuel injection, the picture is muddier, since stock specs show that FI adds 20% to the twin cam. And if your engine is bad shape and needs a rebuild, that's where you should put your \$1000. Especially since you can add high compression pistons or trade up to a 2 liter short block.

Are they loud?

With free-flow air cleaners, they are when you open them up. But so is Pavrotti. The original turtle-back air cleaner produces a mellow bass note that is not substantially louder than a single carb. The free flow air cleaners are much cheaper than a turtleback (by 8X even assuming you can find one of the two new ones rumored to still exist- and used ones command ~\$250). Free flow air cleaners also allow you to see the carbs.

What about a bigger single carb?

It's certainly cheaper and quieter. For example, a new 34ADF (the big brother of the 32ADFA on 1756cc twin cams) is about \$450 new. If you do a lot of city driving, this may be a better idea because low RPMs and idling are less efficient in a dual carb setup. You have a lot more area for the same amount of air leading to low air flow in each barrel at idle and low RPMs. The air velocity through the venturis is too low in a dual carb setup for optimal air/fuel mixing. To get good drivability, your dual setup will end up with richer idle jets to compensate- more fuel, more emissions. On the highway, the opposite effect occurs. RPMs are in the sweet spot, pumping losses are lower and mileage can be higher. I get 27MPG highway with my 40IDFs at 65MPH in a 1756cc engine with 9.8:1 compression. In the suburbs I get 20MPG. If emissions testing is strict be careful about going to dual carbs. Want a good combination of fuel economy, power and emissions? Convert to fuel injection, but it's not as much fun.

Appendix: Dual Weber Carburetors

I saw a dual IDF kit in a catalog. Is this the original factory setup?

If you are looking for 100% authenticity, you won't find it in new parts. The original Fiat factory manifold (called the waffle-top manifold because of the grid pattern cast on it's top) was made by Cromodora and is no longer available new. The advantage of this manifold is that it has coolant jackets like the single carb manifolds do, for faster warm up and for cold days. The original factory air cleaner (called the 'turtle back') is an enclosed black or gray steel air cleaner with an oval element. It is rare, although NOS examples have been reported available from Faza. The advantage of this air cleaner is that it is much quieter than free flow air cleaners. The major disadvantage is cost, and the fact that the carbs are virtually invisible when installed making adjustments more of a chore.

The original linkage for connecting the center linkage between the two carbs to the accelerator pedal is also NLA, and even if it was, would only apply to 1608 models with a special accelerator pedal. This was a mechanical vs. cable linkage and might win Concours points but is actually a poorer design since it can wander as the engine moves around on its mounts. Finally, the carburetors that are available new today are 40IDF-70s and these are different in several details from the 40IDF-13 and 40IDF-15 that were designed for the Fiat twin cam application.

What's the difference?

You can thank the VW dune buggy crowd for the fact that 40IDFs are available new at all, and if you go looking for used IDFs you may find a set configured for VWs for <\$250 used. Add a manifold to fit your Fiat (~\$100 new for the U.S.-made variety) and you may be off to a bargain setup. But whether new or used the typical VW configuration is different than what Fiat engineered:

	40IDF-70	40IDF-13/40IDF-15 (OEM)
Carbs link in center	Not without custom modification*	yes
PCV valve for original air cleaner.	No	yes
vacuum port distributor advance	yes	no
venturi size	28mm*	32mm
main jet	120*	125
air corrector	185*	210
idle jet	.50*	.55
cold starting device	yes*	yes
air horns	no	yes

** all of these items are addressed by the supplier when you buy a new 40IDF kit for the Fiat twin cam. The carbs will have been modified to link together in the center and they will have venturis and jetting for your application.*

If you get a 'good deal' on used VW-style 40IDFs, you can buy all the venturis and jets needed to match the twin cam. But you will still have to find a manifold and modify the right side of one carb and the left side of another to link them in the middle. The difference in time and money spent on jets means that a set of used -13/-15s on a used manifold will command \$200-\$300 more than the VW-style IDFs used at \$250. Any used dual carb setup will often require a rebuild kit at \$40/each.

Appendix: Dual Weber Carburetors

Are they hard to keep in tune?

Opinions vary - Mike Richmond (who wrote the majority of this appendix) says "Not if you stick with a tried and true formula: set them up and tune them. Then leave them alone. Replace the needle/seat and clean them every 24,000 miles." My experience has been that they are generally seasonal, at least in Atlanta I found myself jetting up or down (just the idle jets, mind you) four times a year. Easy work.

Are they hard to tune the first time?

They shouldn't be, but most people make the mistake of failing to install them right the first time (especially used ones) or they change too many things at once. Install them right and be scientific and you will have them humming after a couple of weekends. In the meantime, you will learn to curse in Italian.

You absolutely need a device to measure the amount of air drawn into the carburetor barrels (available from most vendors or carburetor shops) to tune these carburetors correctly. This device measures the amount of airflow into each barrel. The preferred unit is the Type SK (vs. the Type BK) Synchrometer with adapter number 18. This will fit nicely into the ram pipes (velocity stacks) of the IDF 13/15s. The Uni-Syn gauge (another type of metering device) is not recommended for tuning IDFs. A fourth type is available from most motorcycle shops and has four gauges which each attach to the vacuum port at the base each carburetor (next to the air bleed screw). I refer to ALL of these devices as *Synchrometers* in the next topic.

Quick Tuning Guide

First, reset the carburetor to its basic settings. Turn in all four air bleed screws until they are seated. Screw in all four mixture screws until they seat, then back out 1 ½ turns. Adjust the idle stop screw (between the carburetors) so that the engine idles (even if poorly) around 900 RPM.

Balance the airflow between barrels using the synchrometer. First measure the air in both barrels of a single carburetor. Adjust the one with the lowest reading to match the one with the highest reading by adjusting the air bleed screw. Repeat for the other carburetor. Now compare the airflow on one carburetor to the other and balance them using the center link balancing screw.

Set the mixture by turning the mixture screws - one at a time. First turn the screw in, if the engine speed begins to increase keep turning until the speed begins to decrease or run worse then back ½ turn. If the engine speed begins to decrease reverse this operation, turn the screw out and speed will increase, turn until it begins to decrease or run worse then in ½ turn.

Fine tune as necessary using similar steps. These are finesse carburetors, you *will* master them in a very short amount of time!